

CONFIGURAZIONI - CONFIGURATIONS

	1	2x1	3x1	1x2	2+1	2x2
<p>Casi generali di configurazioni modulari: le seguenti indicazioni sono da considerare esempi relativi alle specifiche configurazioni.</p> <p>General cases of modular configurations: please take the following indications as example since they are related to these configurations specifically.</p>						
parete di supporto posteriore back support wall	✓	✓	✓	✓	✓	✓
centro stanza room center	✓	✓	✓	✗	✗	✗
parete di supporto laterale side support wall	✓	✓	✓	✓	✓ parete di sinistra left wall	✗
seguire istruzioni see instructions	1-2-3	1-2-B-3	1-2-B-3	1-2-A-3	1-2-A-B-3	1-2-A-B-3

1 SCEGLIERE IL POSIZIONAMENTO CHOOSE PLACEMENT

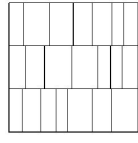
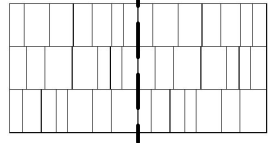
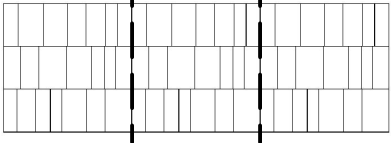
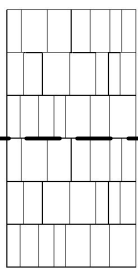
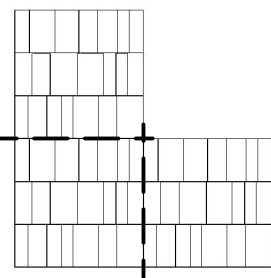
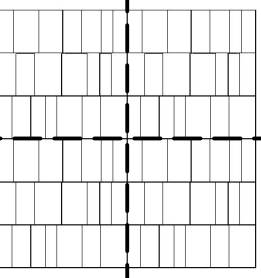
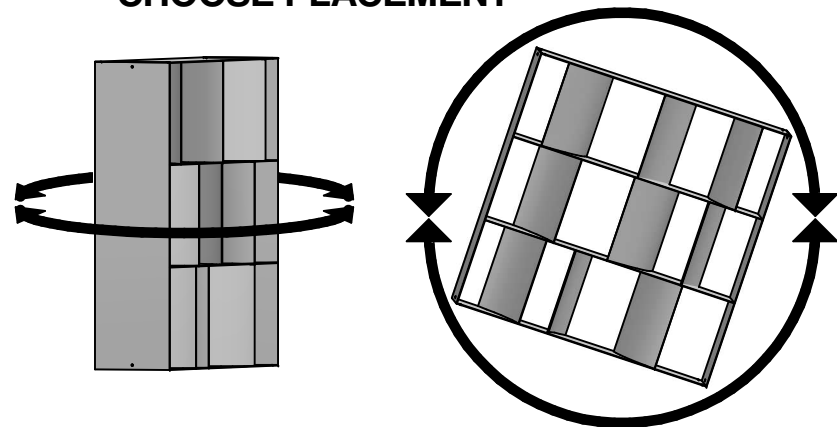

OK

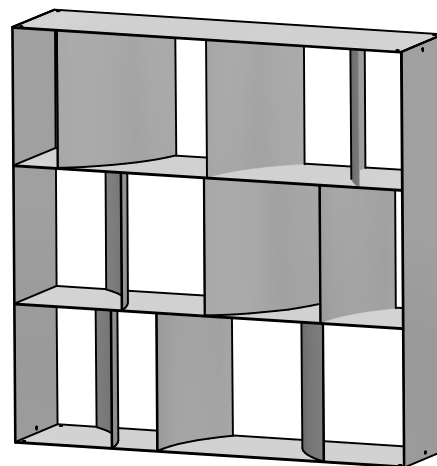

NO

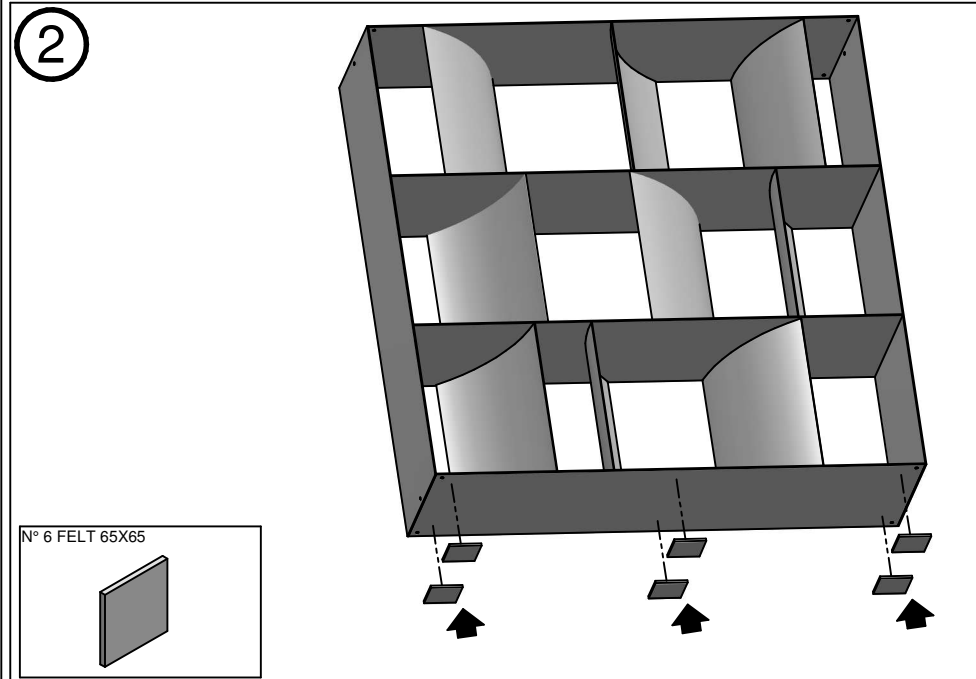
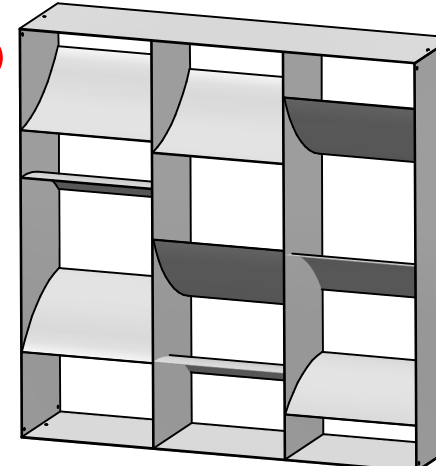

I **USO**
Il prodotto è destinato per l'utilizzo all'interno delle abitazioni con l'uso per il quale è stato realizzato.

REALIZZAZIONE
Piccole irregolarità sulla base sono dovute alla lavorazione manuale del prodotto.

MANUTENZIONE
Non vanno assolutamente utilizzati strumenti metallici appuntiti o panni abrasivi per eliminare eventuali residui di sporco presenti sulla superficie del prodotto, in quanto possono danneggiare la superficie stessa. Non vanno assolutamente utilizzati detersivi che contengano cloro o a base di acido cloridrico, acido muriatico o prodotti anticalcare in quanto andrebbero ad alterare la brillantezza del prodotto.

ATTENZIONE
Non spostare assolutamente mai il prodotto trascinandolo o sollevandolo prendendolo per il piano ma smontarlo e riposizionarlo dove voluto, assicurandosi di proteggere le parti che si potrebbero danneggiare.

SMALTIMENTO
Una volta smesso, il prodotto od i suoi componenti non vanno dispersi nell'ambiente ma conferiti ai sistemi pubblici di smaltimento.
Riporre per eventuali consultazioni future.

UK **USE**
The product is intended to be used in the inside and for the purposes it was created for.

ACCOMPLISHMENT
Small irregularities on the base are due to manual processing.

MAINTENANCE
It is recommended not to use metal sharp tools or abrasive clothes to eliminate dirt from the surface, because they could damage the same. Do not absolutely use detergents containing chlorine, muriatic acid, hydrochloric acid or descale detergents which can damage the surface brilliance.

WARNING
Do not absolutely move the product dragging it or lifting it by gripping the top, but disassemble it and then place it in the new site, protecting the parts that could be damaged.

DISPOSAL
Once discarded, neither the product nor its components should be dispersed in the environment, but rather consigned to public disposal systems.
File for future consultation.

D **NUTZUNG**
Das Produkt ist nur für den Innenbereich gedacht. Der Tisch wurde hergestellt, nur als Esstisch genutzt zu werden.

AUSFÜHRUNG
Kleine Unregelmäßigkeiten auf der Basis sind nicht zu vermeiden, da das Teil per Hand hergestellt wird.

WARTUNG
Niemals scharfe Werkzeuge aus Metall, spitzen Instrumente oder Schleifmittel für die Reinigung der Oberfläche verwenden. Diese Produkte können die Oberfläche beschädigen. Niemals Chemikalien mit chlorhaltigen Salzsäure, Salzsäure oder Kalk-Produkte für die Reinigung verwenden. Diese Produkte können der Glanz beschädigen.

ACHTUNG
Der Tisch absolut nie ziehen oder heben. Falls der Tisch soll bewegt werden, muss zerlegt werden und sorgfältig in der neue Stelle positioniert. Die empfindliche teile sollen geschützt werden.

ENTSORGUNG
Nach der Aussonderung ist das Produkt und seine Bestandteile nicht selbständig im Freien zu entsorgen, sondern der städtischen Müllabfuhr zu übergeben.
Bitte aufbewahren für eventuelle spätere Nachfragen.

F **UTILISATION**
Le produit est destiné pour une utilisation à l'intérieur des habitations.

CONSTRUCTION
Les petites irrégularités sur la base sont dues à une fabrication manuelle.

MANUTENTION
Il ne faut pas absolument utiliser des outils pointus ou des chiffons abrasifs pour éliminer des possibles restes sur la surface du produit, parce qu'ils peuvent endommager la surface même. Ne pas utiliser des détergents contenant du chlore, acide chlorhydrique, acide muriatique ou produits anticalcaire qui peuvent altérer le brillant du produit.

ATTENTION
Ne pas absolument déplacer le produit en le trainant ou en le soulevant par le top, mais démontez-le et positionnez-le autre part, en s'assurant de protéger les parties qui pourraient s'endommager.

ECOULEMENT
Une fois disloqué, le produit ou ses composants ne doivent pas être dispersés dans la nature mais confiés aux décharges publiques.
A conserver pour les futurs besoins de reference.

E **USO**
El producto está destinado para su uso dentro del hogar, a los fines por los cuales fue creado.

CONSTRUCCIÓN
Pequeñas irregularidades en la base están causadas por la producción manual.

MANTENIMIENTO
No utilizar en cualquier forma instrumentos de metal afilados o telas abrasivas para eliminar cualquier resto de suciedad en la superficie del producto, ya que pueden dañar la superficie misma. No utilizar en cualquier forma limpiadores a base de cloro o que contienen ácido clorhídrico, ácido muriático o productos anticalcáreos ya que pueden alterar el brillo del producto.

ATENCIÓN
No muevan absolutamente nunca el producto arrastrándolo o mediante el levantamiento del plano, sino desmontarlo y llevarlo a donde querían, asegurándose de proteger las partes que pueden dañarse.

ELIMINACIÓN DE DESECHOS
Una vez desechado, el producto o sus componentes no se tienen que abandonar en el entorno sino entregar al sistema público de recogida de basuras.
Guardar para consultas posteriores.

A FISSAGGIO VERTICALE - VERTICAL FIXING

X2

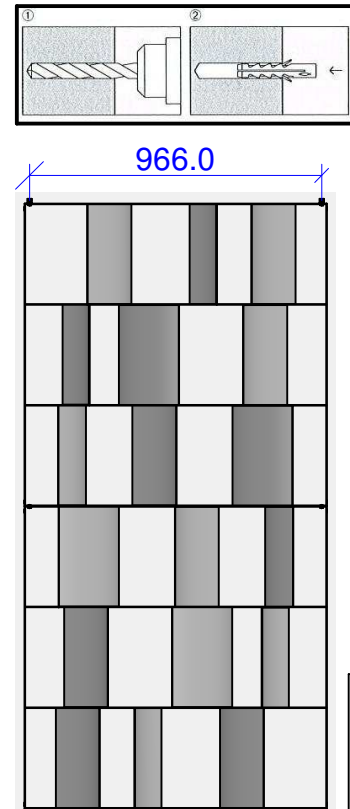
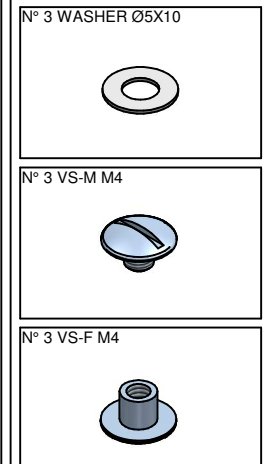
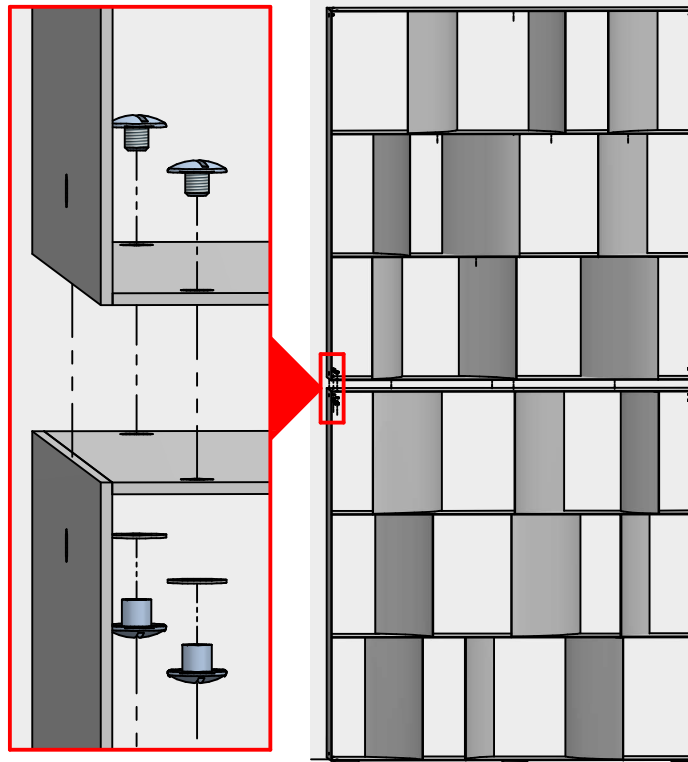

FISSAGGIO A PARETE - WALL FIXING

X2

X2

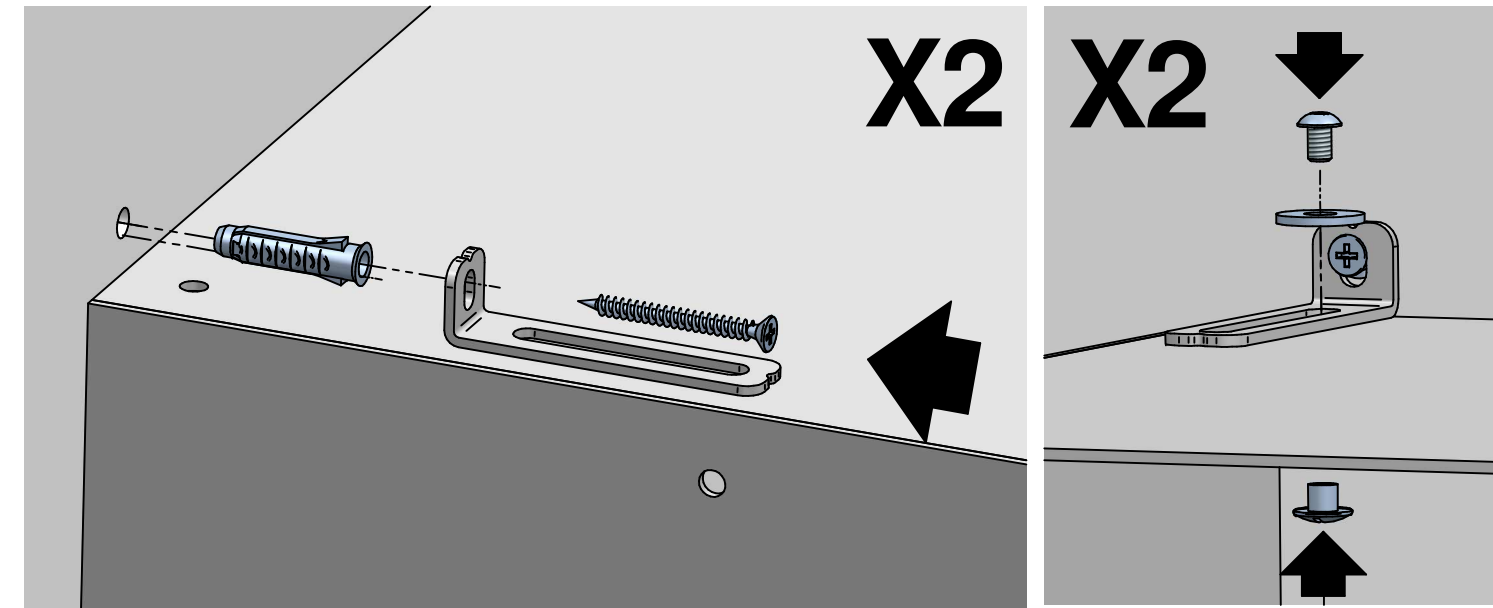

B FISSAGGIO LATERALE
 SIDE FIXING

X2

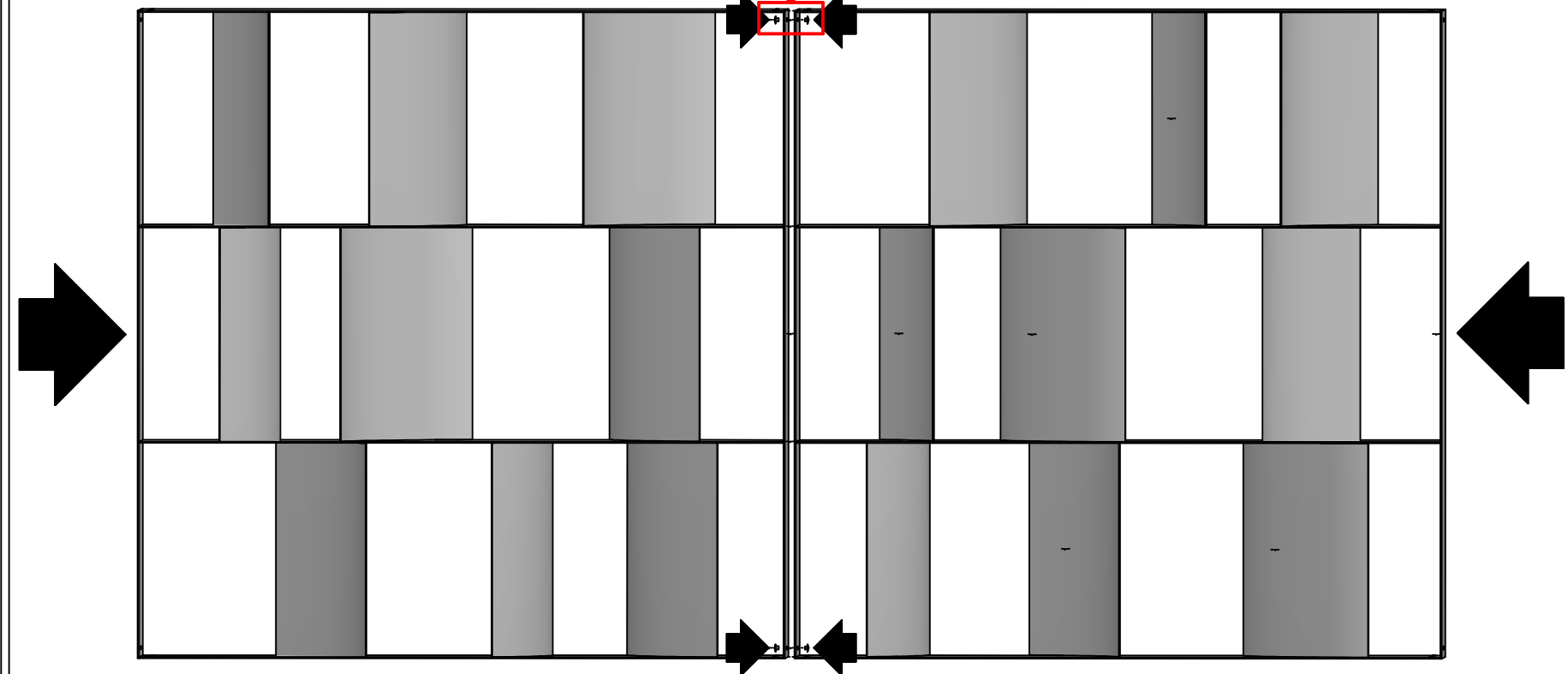
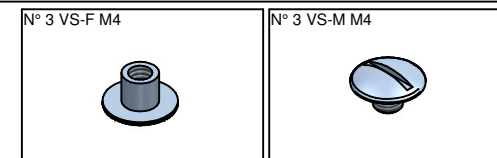
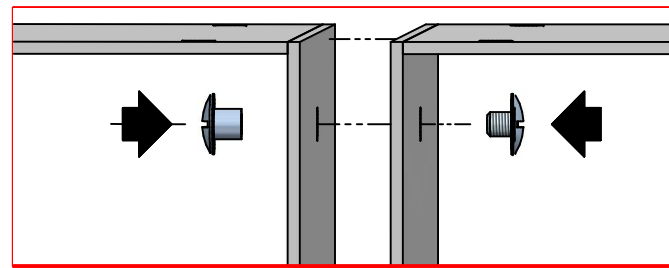

3

COPRIRE FORI CON BLISTER
 COVER HOLES WITH BLISTERS

