

Atlantis, a precious *wave*.

design Barlas Baylar
terzani.com



Product Name







Atlantis
small three tier chandelier

Materials

brass chains and metal
structure plated as below



Finishes | Code

-  nickel
0A13S E7 C8
-  black nickel
0A13S E9 C8
-  bronze
0A13S F7 C8
-  gold
0A13S L6 C8
-  champagne
0A13S N1 C8
-  brushed champagne
0A13S N7 C8

Body

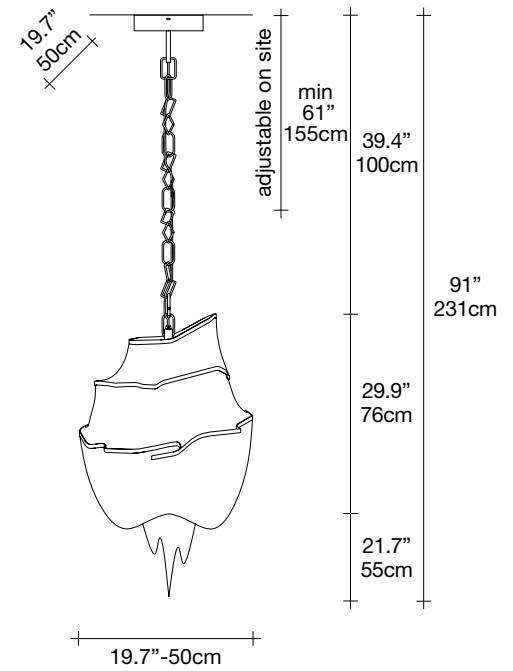

Recommended Light

120V ~ 50/60Hz

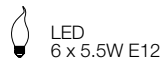

dimmable with

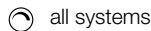



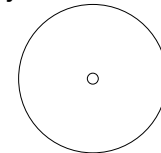



Canopy

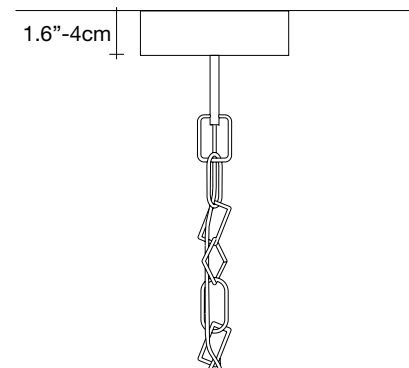

Ø5.5"-14cm

Seemingly alive, atlantis' shimmering light creates a vibrant source of energy. Its mesmerizing, organic effect is created by hundreds of illuminated lengths of draped, nickel chain. Like water in the ocean, atlantis' chains appear liquid, cascading over its gloss nickel bands and falling down towards the abyss before turning back into itself. Atlantis is composed of almost three miles of chain, meticulously hand-crafted by master italian artisans. Design Barlas Baylar.



-  lbs 39.7
-  lbs 119
-  29.5" x 29.5" x 45.3"
-  kg 18
-  kg 54
-  75 x 75 x 114 cm

Atlantis, a precious *wave*.

design Barlas Baylar
terzani.com









Product Name
Atlantis
medium three tier chandelier

Materials
brass chains and metal
structure plated as below



Finishes | Code

-  nickel
0A14S E7 C8
-  black nickel
0A14S E9 C8
-  bronze
0A14S F7 C8
-  gold
0A14S L6 C8
-  champagne
0A14S N1 C8
-  brushed champagne
0A14S N7 C8

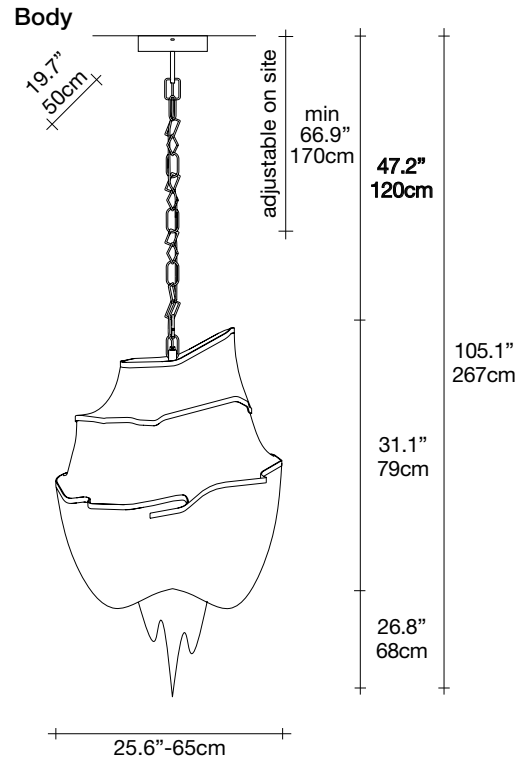

Recommended Light

120V ~ 50/60Hz

 LED
8 x 5.5W E12

dimmable with

 all systems

Canopy

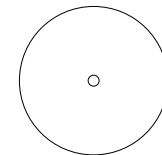

Ø5.5"-14cm

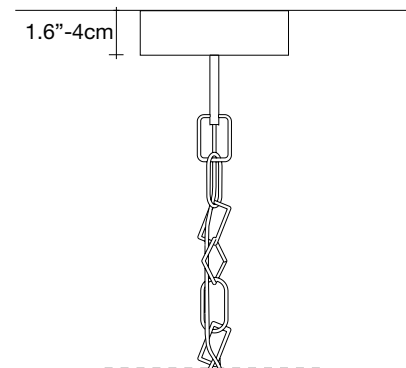

Seemingly alive, atlantis' shimmering light creates a vibrant source of energy. Its mesmerizing, organic effect is created by hundreds of illuminated lengths of draped, nickel chain. Like water in the ocean, atlantis' chains appear liquid, cascading over its gloss nickel bands and falling down towards the abyss before turning back into itself. Atlantis is composed of almost three miles of chain, meticulously hand-crafted by master italian artisans. Design Barlas Baylar.

Atlantis, a precious *wave*.

design Barlas Baylar
terzani.com









Product Name
Atlantis
large three tier chandelier

Materials
brass chains and metal
structure plated as below



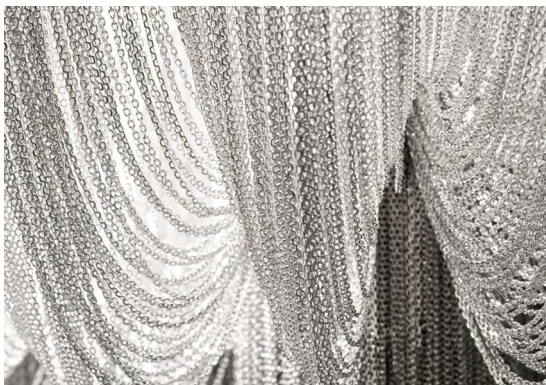
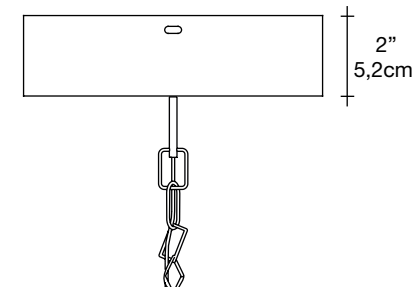
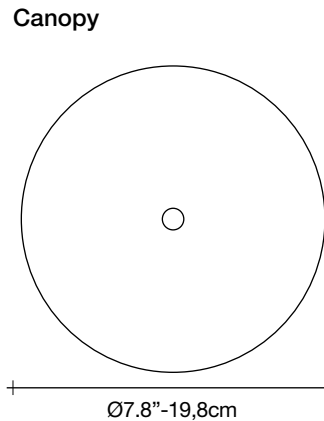
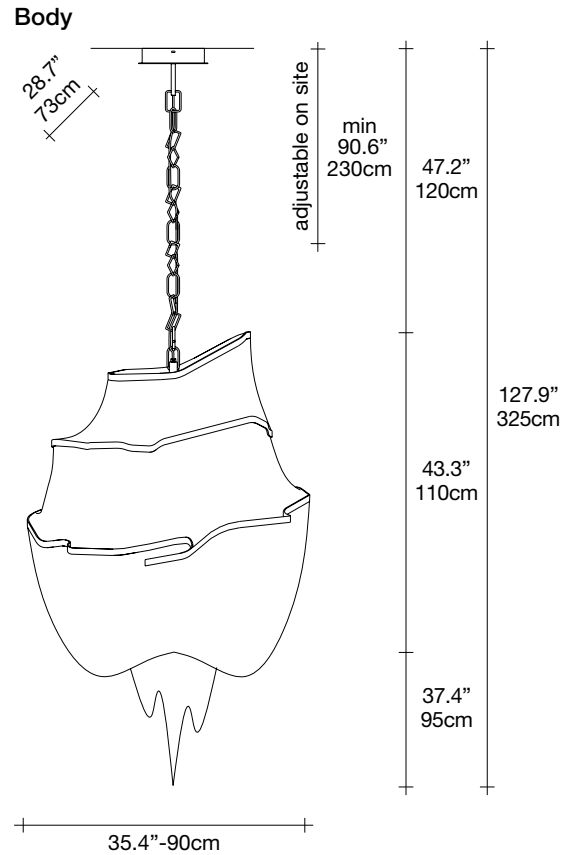

Finishes | Code

-  nickel
0A15S E7 C8
-  black nickel
0A15S E9 C8
-  bronze
0A15S F7 C8
-  gold
0A15S L6 C8
-  champagne
0A15S N1 C8
-  brushed champagne
0A15S N7 C8



Recommended Light
120V ~ 50/60Hz

-  LED
8 x 5.5W E12
- dimmable with
-  all systems

Seemingly alive, atlantis' shimmering light creates a vibrant source of energy. Its mesmerizing, organic effect is created by hundreds of illuminated lengths of draped, nickel chain. Like water in the ocean, atlantis' chains appear liquid, cascading over its gloss nickel bands and falling down towards the abyss before turning back into itself. Atlantis is composed of almost three miles of chain, meticulously hand-crafted by master italian artisans. Design Barlas Baylar.

 lbs 82
  lbs 201
  45.3" x 33.4" x 59.1"
 kg 37
  kg 91
 115 x 85 x 150 cm

Atlantis, a precious *wave*.

design Barlas Baylar
terzani.com



Product Name







Atlantis
small linear chandelier

Materials

brass chains and metal structure plated as below



Finishes | Code

-  nickel
0A18S E7 C8
-  black nickel
0A18S E9 C8
-  bronze
0A18S F7 C8
-  gold
0A18S L6 C8
-  champagne
0A18S N1 C8
-  brushed champagne
0A18S N7 C8

Body

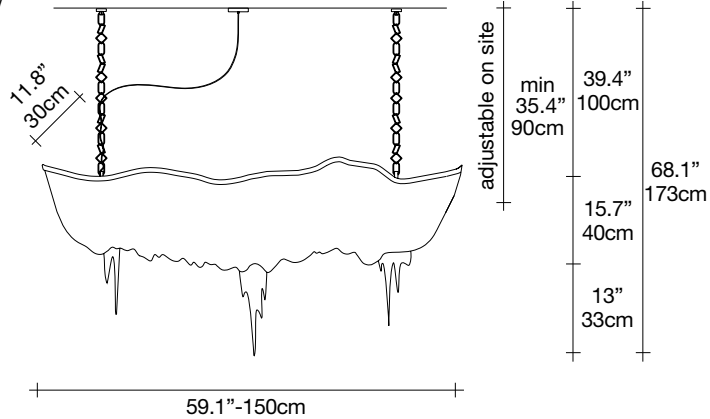

Recommended Light

120V ~ 50/60Hz

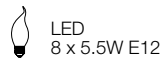

dimmable with

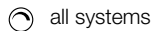

Canopy

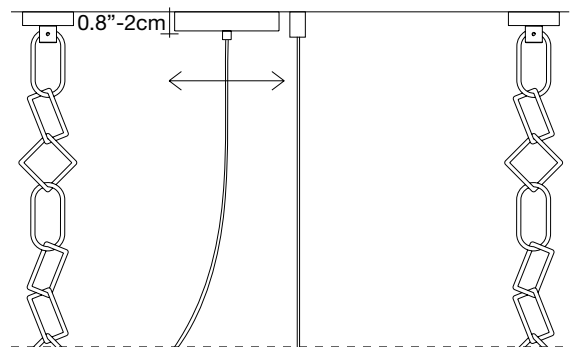
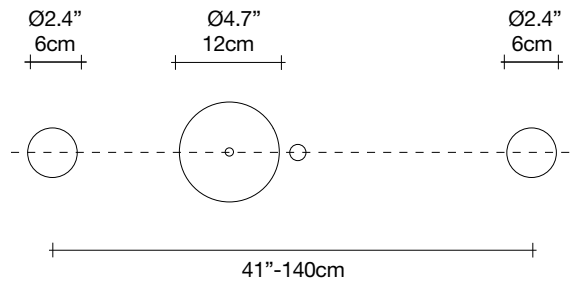

Seemingly alive, atlantis' shimmering light creates a vibrant source of energy. Its mesmerizing, organic effect is created by hundreds of illuminated lengths of draped, nickel chain. Like water in the ocean, atlantis' chains appear liquid, cascading over its gloss nickel bands and falling down towards the abyss before turning back into itself. Atlantis is composed of almost three miles of chain, meticulously hand-crafted by master italian artisans. Design Barlas Baylar.

Atlantis, a precious *wave*.

design Barlas Baylar
terzani.com









Product Name
Atlantis
medium linear chandelier

Materials
brass chains and metal
structure plated as below



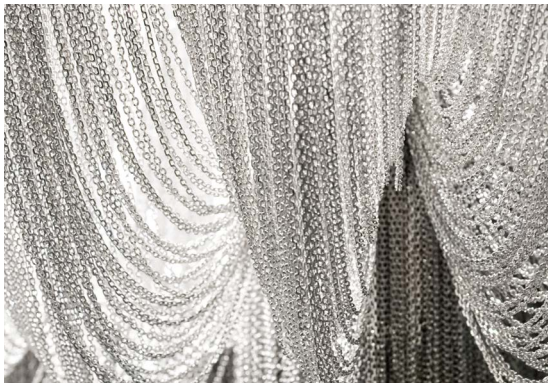
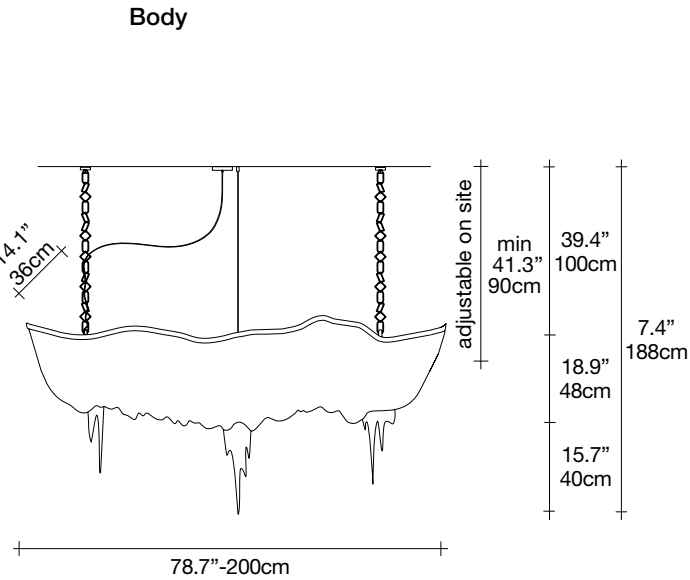

Finishes | Code

-  nickel
0A17S E7 C8
-  black nickel
0A17S E9 C8
-  bronze
0A17S F7 C8
-  gold
0A17S L6 C8
-  champagne
0A17S N1 C8
-  brushed champagne
0A17S N7 C8



Recommended Light
120V ~ 50/60Hz

-  LED
10 x 5.5W E12
- dimmable with**
-  all systems

Canopy

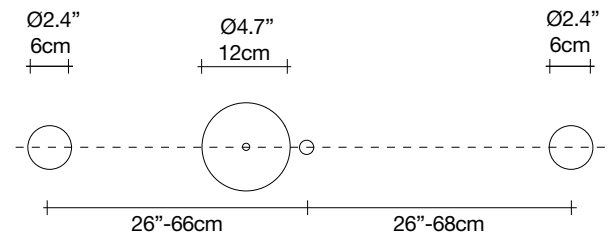

Seemingly alive, atlantis' shimmering light creates a vibrant source of energy. Its mesmerizing, organic effect is created by hundreds of illuminated lengths of draped, nickel chain. Like water in the ocean, atlantis' chains appear liquid, cascading over its gloss nickel bands and falling down towards the abyss before turning back into itself. Atlantis is composed of almost three miles of chain, meticulously hand-crafted by master italian artisans. Design Barlas Baylar.

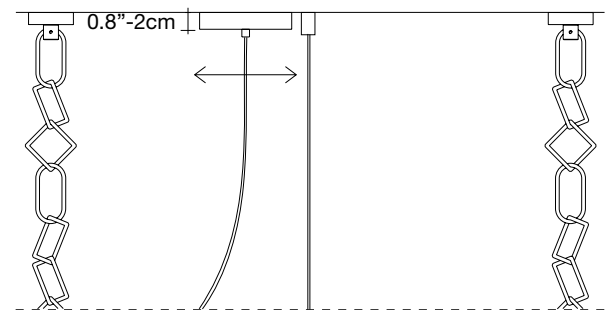

-  lbs 90.4
kg 41
-  lbs 216
kg 98
-  86.6" x 27.6" x 41.7"
215 x 65 x 104 cm

Atlantis, a precious wave.

design Barlas Baylar
terzani.com









Product Name
Atlantis
large linear chandelier

Materials
brass chains and metal
structure plated as below





Finishes | Code

-  nickel
0A16S E7 C8
-  black nickel
0A16S E9 C8
-  bronze
0A16S F7 C8
-  gold
0A16S L6 C8
-  champagne
0A16S N1 C8
-  brushed champagne
0A16S N7 C8

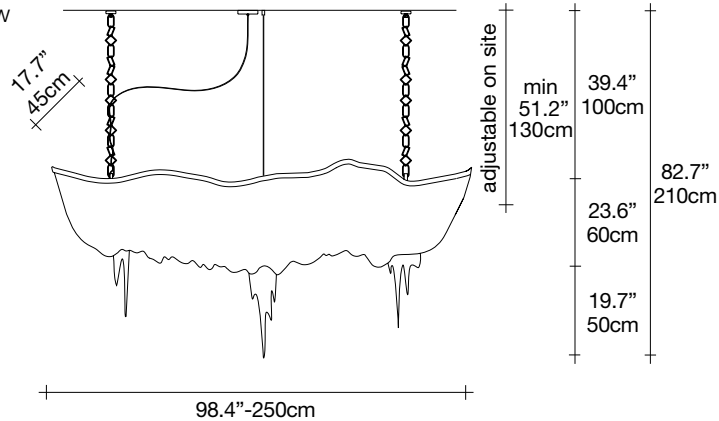
Body







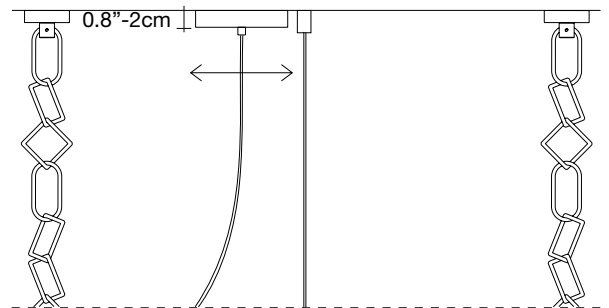
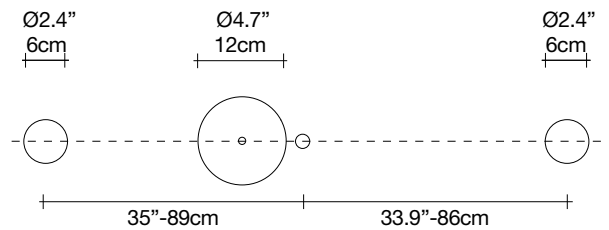

Recommended Light
120V ~ 50/60Hz

-  LED
10 x 5.5W E12
- dimmable with**
-  all systems

Canopy



Seemingly alive, atlantis' shimmering light creates a vibrant source of energy. Its mesmerizing, organic effect is created by hundreds of illuminated lengths of draped, nickel chain. Like water in the ocean, atlantis' chains appear liquid, cascading over its gloss nickel bands and falling down towards the abyss before turning back into itself. Atlantis is composed of almost three miles of chain, meticulously hand-crafted by master italian artisans. Design Barlas Baylar.

-  lbs 146  lbs 322  108.3" x 29.5" x 45.7"
-  kg 66  kg 146  270 x 70 x 114 cm

Atlantis, a precious *wave*.

design Barlas Baylar
terzani.com



Product Name



Atlantis
two tier chandelier

Materials

brass chains and metal
structure plated as below



Finishes | Code

-  nickel
OJ01S E7 C8
-  black nickel
OJ01S E9 C8
-  bronze
OJ01S F7 C8
-  gold
OJ01S L6 C8
-  champagne
OJ01S N1 C8
-  brushed champagne
OJ01S N7 C8

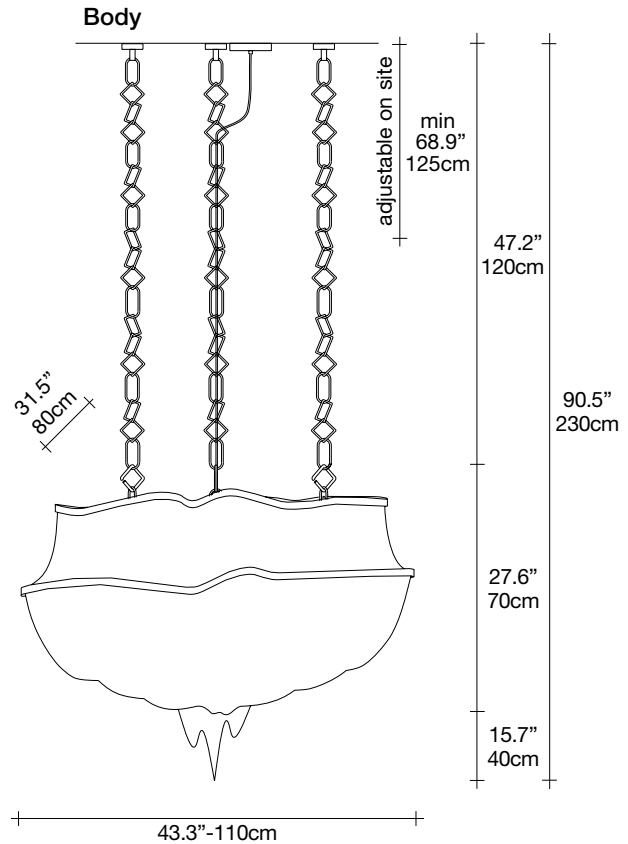

Recommended Light

120V ~ 50/60Hz

 LED
8 x 5.5W E12

dimmable with

 all systems

Canopy

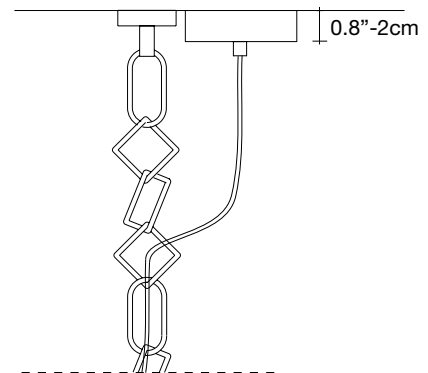
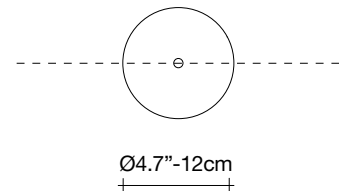

Seemingly alive, atlantis' shimmering light creates a vibrant source of energy. Its mesmerizing, organic effect is created by hundreds of illuminated lengths of draped, nickel chain. Like water in the ocean, atlantis' chains appear liquid, cascading over its gloss nickel bands and falling down towards the abyss before turning back into itself. Atlantis is composed of almost three miles of chain, meticulously hand-crafted by master italian artisans. Design Barlas Baylar.

Atlantis, a precious *wave*.

design Barlas Baylar
terzani.com

TERZANI
LA LUCE PENSATA



Product Name
Atlantis
small wall sconce

Materials
brass chains and metal
structure plated as below



Finishes | Code

-  nickel
OJ04A E7 C8
-  black nickel
OJ04A E9 C8
-  bronze
OJ04A F7 C8
-  gold
OJ04A L6 C8
-  champagne
OJ04A N1 C8
-  brushed champagne
OJ04A N7 C8

Body

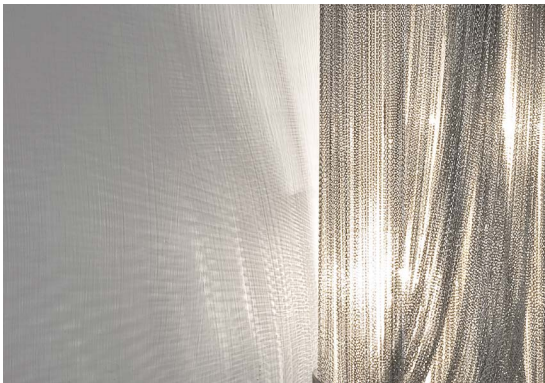
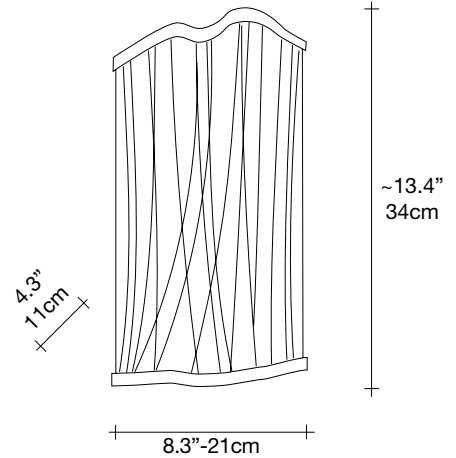

Recommended Light
120V ~ 50/60Hz

 LED
2 x 5.5W E12

dimmable with

 all systems

Canopy

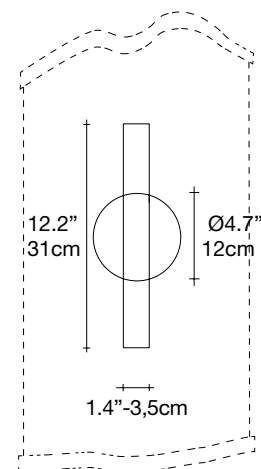

Seemingly alive, atlantis' shimmering light creates a vibrant source of energy. Its mesmerizing, organic effect is created by hundreds of illuminated lengths of draped, nickel chain. Like water in the ocean, atlantis' chains appear liquid, cascading over its gloss nickel bands and falling down towards the abyss before turning back into itself. Atlantis is composed of almost three miles of chain, meticulously hand-crafted by master italian artisans. Design Barlas Baylar.

Atlantis, a precious *wave*.

design Barlas Baylar
terzani.com



Product Name
Atlantis
large wall sconce

Materials
brass chains and metal
structure plated as below





Finishes | Code

-  nickel
OJ03A E7 C8
-  black nickel
OJ03A E9 C8
-  bronze
OJ03A F7 C8
-  gold
OJ03A L6 C8
-  champagne
OJ03A N1 C8
-  brushed champagne
OJ03A N7 C8

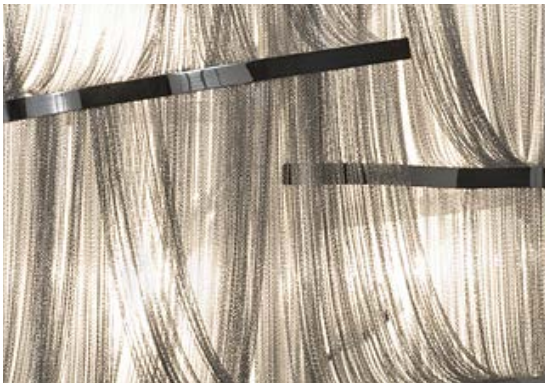
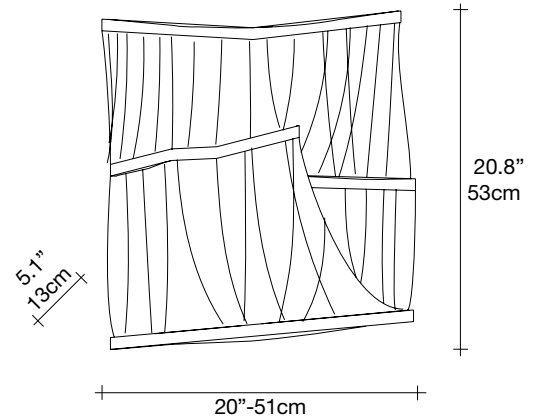
Body



Recommended Light
120V ~ 50/60Hz

-  LED
4 x 5.5W E12
- dimmable with**
-  all systems

Canopy

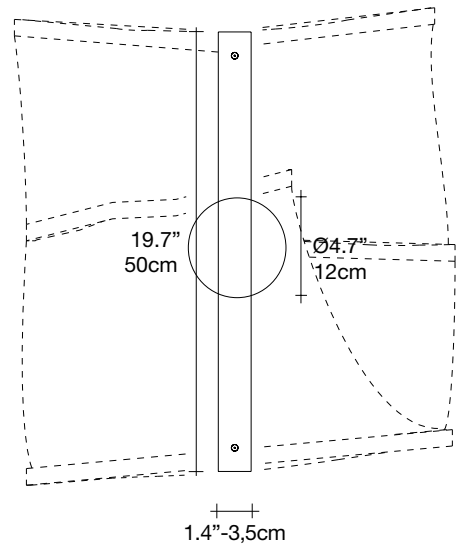

Seemingly alive, atlantis' shimmering light creates a vibrant source of energy. Its mesmerizing, organic effect is created by hundreds of illuminated lengths of draped, nickel chain. Like water in the ocean, atlantis' chains appear liquid, cascading over its gloss nickel bands and falling down towards the abyss before turning back into itself. Atlantis is composed of almost three miles of chain, meticulously hand-crafted by master italian artisans. Design Barlas Baylar.